

Serie di proiettori orientabili da interni

Emissione: diretta

Riflettori: tre parabole con diversi angoli luminosi 12°, 24°, 48°

Cablaggi: CAE (con alimentatore elettronico)

Colori disponibili:

- ☐ 01 bianco RAL 9016
- ☐ 05 grigio RAL 9006

Sistema di fissaggio: a plafone o con adattatore per binario (non incluso)

Indoor adjustable sources

Emission: direct

Reflector: three parabolas with different angles of light 12°, 24°, 48°

Wiring: CAE (with high frequency ballast)

Available colours:

- ☐ 01 white RAL 9016
- ☐ 05 gray RAL 9006

Fixing kit: surface mounting or track adapter (not included)

A richiesta - On request:



vedi "come leggere il catalogo" (pag. 1)
see "how to read the catalogue" (page 1)

cod. **LJR70** Jerry



Articolo Code	Potenza Power (Watt)	Attacco Pin	Peso Weight (kg)
•• LJR7035/12/ *	1x35 - 12°	G12	2,0
•• LJR7035/24/ *	1x35 - 24°	G12	2,0
•• LJR7035/48/ *	1x35 - 48°	G12	2,0
•• LJR7070/12/ *	1x70 - 12°	G12	2,5
•• LJR7070/24/ *	1x70 - 24°	G12	2,5
•• LJR7070/48/ *	1x70 - 48°	G12	2,5

- * = tipo di cablaggio - wiring type (CAE)
- = codice consegna (pag. 8) - delivery code (pag. 8)

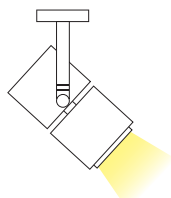
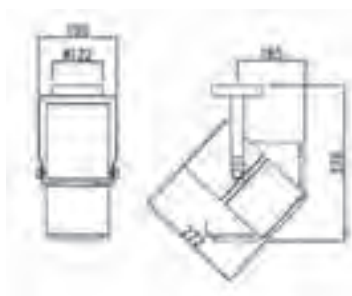

cod. **LJR71** Maxi Jerry

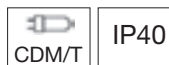

Articolo Code	Potenza Power (Watt)	Attacco Pin	Peso Weight (kg)
•• LJR71150/12/ *	1x150 - 12°	G12	3,0
•• LJR71150/24/ *	1x150 - 24°	G12	3,0
•• LJR71150/48/ *	1x150 - 48°	G12	3,0

- * = tipo di cablaggio - wiring type (CAE)
- = codice consegna (pag. 8) - delivery code (pag. 8)

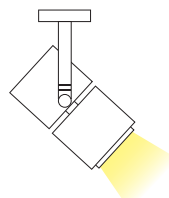

cod. **KT** accessori a richiesta

- **KT21010** - basetta attacco a plafone assemblata - wall fixing bracket
- **KT21011** - adattatore per binario assemblato - adapter for track assembly
- = codice consegna (pag. 8) - delivery code (pag. 8)

cod. **F** filtri - filter



Articolo Code	descrizione description
FBR	filtro pane - bread filter
FFH	filtro pesce - fish filter
FNT	filtro carne - meat filter
FVE	filtro verdura - vegetable filter
FFR	filtro frutta - fruit filter

**Serie di proiettori orientabili da interni****Emissione:** diretta**Cablaggi:** CAE (con alimentatore elettronico)**Colori disponibili:**

- 01** bianco RAL 9016
- 05** grigio RAL 9006

Sistema di fissaggio: a plafone o con adattatore per binario (non incluso)**A richiesta:** finitura diversa dallo standard**Indoor adjustable sources****Emission:** direct**Wiring:** CAE (with high frequency ballast)**Available colours:**

- 01** white RAL 9016
- 05** gray RAL 9006

Fixing kit: surface mounting or track adapter (not included)**On request:** other optional finishescod. **ML6291** orientabile

Articolo Code	descrizione description	attacco pin
•• ML6291/0/ *	1x50W - alogena	GY6.35
•• ML6291/1/ *	1x100W - alogena	GY6.35

* = tipo di cablaggio - wiring type (CAE)

• = codice consegna (pag. 8) - delivery code (pag. 8)

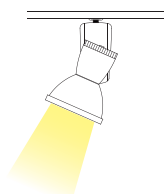
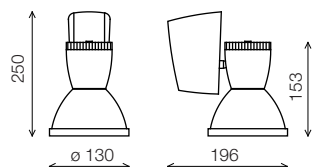
cod. **KT** accessori a richiesta

- **KT21010** - basetta attacco a plafone assemblata
- wall fixing bracket
- **KT21011** - adattatore per binario assemblato
- adapter for track assembly

• = codice consegna (pag. 8) - delivery code (pag. 8)



Serie di proiettori orientabili da interni

Emissione: diretta

Cablaggi: CAE (con alimentatore elettronico)

Colori disponibili:

- ☐ 01 bianco RAL 9016
- ☐ 05 grigio RAL 9006

Sistema di fissaggio: a plafone o con adattatore per binario (non incluso)

A richiesta: finitura diversa dallo standard

Indoor adjustable sources

Emission: direct

Wiring: CAE (with high frequency ballast)

Available colours:

- ☐ 01 white RAL 9016
- ☐ 05 gray RAL 9006

Fixing kit: surface mounting or track adapter (not included)

On request: other optional finishes

A richiesta - On request:



vedi "come leggere il catalogo" (pag. 1)
see "how to read the catalogue" (page 1)

cod. **JI7261** orientabile



Articolo Code	descrizione description	attacco pin
•• JI7261/0/12/ *	1x35W - CDM-T	G12
•• JI7261/0/24/ *	1x35W - CDM-T	G12
•• JI7261/0/48/ *	1x35W - CDM-T	G12
•• JI7261/1/12/ *	1x70W - CDM-T	G12
•• JI7261/1/24/ *	1x70W - CDM-T	G12
•• JI7261/1/48/ *	1x70W - CDM-T	G12
•• JI7261/2/ *	1xAR111 (max 75W)	G53

- * = tipo di cablaggio - wiring type (CAE)
- = codice consegna (pag. 8) - delivery code (pag. 8)

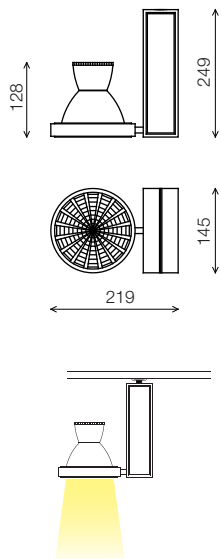

cod. **JI7262** orientabile

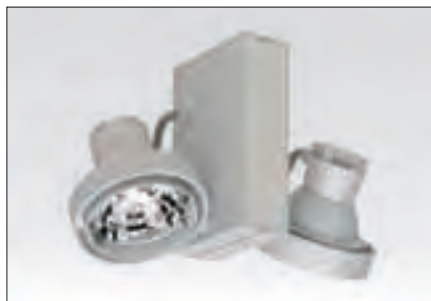

Articolo Code	descrizione description	attacco pin
•• JI7262/0/12/ *	2x35W - CDM-T	G12
•• JI7262/0/24/ *	2x35W - CDM-T	G12
•• JI7262/0/48/ *	2x35W - CDM-T	G12
•• JI7262/1/12/ *	2x70W - CDM-T	G12
•• JI7262/1/24/ *	2x70W - CDM-T	G12
•• JI7262/1/48/ *	2x70W - CDM-T	G12
•• JI6262/2/ *	2xAR111 (max 75W)	G53

- * = tipo di cablaggio - wiring type (CAE)
- = codice consegna (pag. 8) - delivery code (pag. 8)

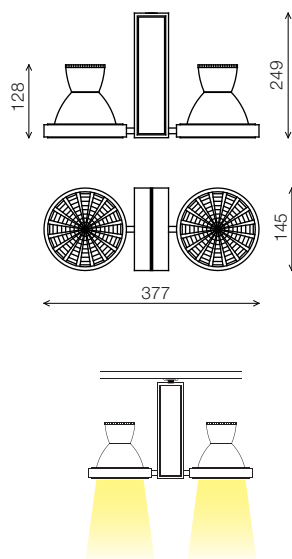

cod. **KT** accessori a richiesta

- **KT21010** - basetta attacco a plafone assemblata
- wall fixing bracket
- **KT21011** - adattatore per binario assemblato
- adapter for track assembly
- = codice consegna (pag. 8) - delivery code (pag. 8)

cod. **F** filtri - filter



Articolo Code	descrizione description
FBR	filtro pane - bread filter
FFH	filtro pesce - fish filter
FNT	filtro carne - meat filter
FVE	filtro verdura - vegetable filter
FFR	filtro frutta - fruit filter



Serie di proiettori orientabili da interni

Emissione: diretta

Cablaggi: CAE (con alimentatore elettronico)

Colori disponibili:

- ☐ 01 bianco RAL 9016
- ☐ 05 grigio RAL 9006

Sistema di fissaggio: a plafone o con adattatore per binario (non incluso)

A richiesta: finitura diversa dallo standard

Indoor adjustable sources

Emission: direct

Wiring: CAE (with high frequency ballast)

Available colours:

- ☐ 01 white RAL 9016
- ☐ 05 gray RAL 9006

Fixing kit: surface mounting or track adapter (not included)

On request: other optional finishes

cod. **TO6271** orientabile



Articolo Code	descrizione description	attacco pin
•• TO6271/0/12/ *	1x35W - CDM-T	G12
•• TO6271/0/24/ *	1x35W - CDM-T	G12
•• TO6271/0/48/ *	1x35W - CDM-T	G12
•• TO6271/1/12/ *	1x70W - CDM-T	G12
•• TO6271/1/24/ *	1x70W - CDM-T	G12
•• TO6271/1/48/ *	1x70W - CDM-T	G12

* = tipo di cablaggio - wiring type (CAE)
 • = codice consegna (pag. 8) - delivery code (pag. 8)

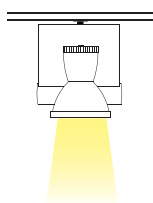
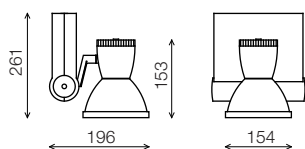

cod. **F** filtri - filter



Articolo Code	descrizione description
FBR	filtro pane - bread filter
FFH	filtro pesce - fish filter
FNT	filtro carne - meat filter
FVE	filtro verdura - vegetable filter
FFR	filtro frutta - fruit filter

cod. **KT** accessori a richiesta

- **KT21010** - basetta attacco a plafone assemblata - wall fixing bracket
 - **KT21011** - adattatore per binario assemblato - adapter for track assembly
- = codice consegna (pag. 8) - delivery code (pag. 8)

12° Fascio stretto - Narrow beam

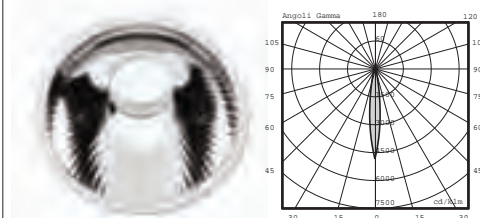

24° Fascio medio - Medium beam

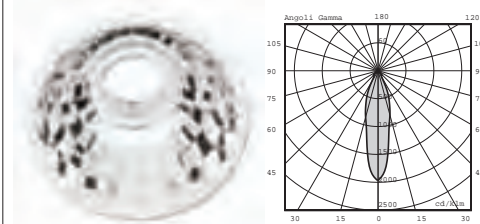

48° Fascio largo - Wide beam

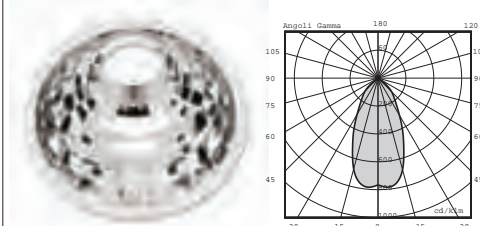



Serie di proiettori orientabili da interni

Emissione: diretta

Cablaggi: CR (rifasato) - CAE (con alimentatore elettronico)

Colori disponibili:

- 01 bianco RAL 9016
- 05 grigio RAL 9006

Sistema di fissaggio: a plafone o con adattatore per binario (non incluso)

A richiesta: finitura diversa dallo standard

Indoor adjustable sources

Emission: direct

Wiring: CR (high power factor) - CAE (with high frequency ballast)

Available colours:

- 01 white RAL 9016
- 05 gray RAL 9006

Fixing kit: surface mounting or track adapter (not included)

On request: other optional finishes

A richiesta - On request:



vedi "come leggere il catalogo" (pag. 1)
see "how to read the catalogue" (page 1)

cod. **BN6252** orientabile



IP20

Articolo Code	descrizione description	attacco pin
•• BN6252/0/48/ *	1x35W - SDW-T	PG12
•• BN6252/1/48/ *	1x50W - SDW-T	PG12
•• BN6252/2/48/ *	1x100W - SDW-T	PG12

- * = tipo di cablaggio - wiring type (CR - CAE)
- = codice consegna (pag. 8) - delivery code (pag. 8)

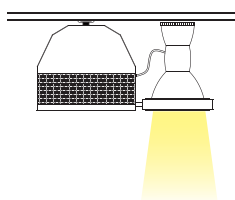
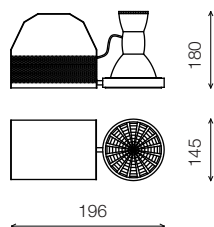

cod. **BN6252** orientabile



IP20

Articolo Code	descrizione description	attacco pin
•• BN6252/3/12/ *	1x35W - CDM-T	G12
•• BN6252/3/24/ *	1x35W - CDM-T	G12
•• BN6252/3/48/ *	1x35W - CDM-T	G12
•• BN6252/4/12/ *	1x70W - CDM-T	G12
•• BN6252/4/24/ *	1x70W - CDM-T	G12
•• BN6252/4/48/ *	1x70W - CDM-T	G12

- * = tipo di cablaggio - wiring type (CR - CAE)
- = codice consegna (pag. 8) - delivery code (pag. 8)

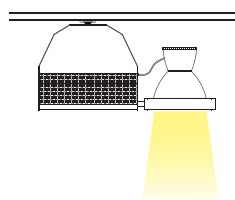
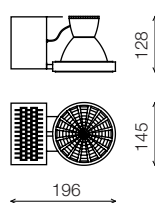

cod. **KT** accessori a richiesta

- **KT21010** - basetta attacco a plafone assemblata - wall fixing bracket
- **KT21011** - adattatore per binario assemblato - adapter for track assembly
- = codice consegna (pag. 8) - delivery code (pag. 8)

cod. **F** filtri - filter



Articolo Code	descrizione description
FBR	filtro pane - bread filter
FFH	filtro pesce - fish filter
FNT	filtro carne - meat filter
FVE	filtro verdura - vegetable filter
FFR	filtro frutta - fruit filter



Serie di proiettori orientabili da interni

Emissione: diretta

Cablaggi: CAE (con alimentatore elettronico)

Colori disponibili:

- ☐ 01 bianco RAL 9016
- 02 nero RAL 9005
- 05 grigio RAL 9006

Sistema di fissaggio: adattatore per binario (incluso)

A richiesta: finitura diversa dallo standard

Indoor adjustable sources

Emission: direct

Wiring: CAE (with high frequency ballast)

Available colours:

- ☐ 01 white RAL 9016
- 02 black RAL 9005
- 05 gray RAL 9006

Fixing kit: track adapter (included)

On request: other optional finishes

cod. **SV6252** Steve



Articolo Code	descrizione description	attacco pin
•• SV62523/ *	1x35W - CDM-R 111	GX8.5
•• SV62524/ *	1x70W - CDM-R 111	GX8.5
•• SV62525/ *	1x50W - AR 111	G53

- * = tipo di cablaggio - wiring type (CAE)
- = codice consegna (pag. 8) - delivery code (pag. 8)

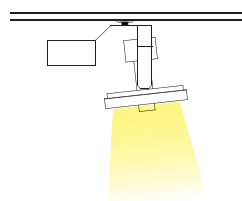
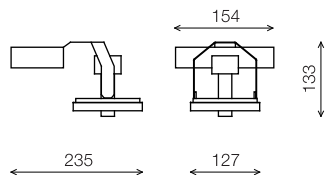

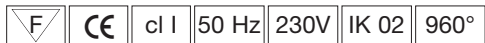

Serie di apparecchi regolabili per uso interno.

Emissione: diretta

Ottica: alluminio puro sabbiato e anodizzato

Cablaggi: CR (elettromeccanico rifasato) - CAE (con alimentatore elettronico)

Colori disponibili:

- 01 bianco RAL 9016
- 05 grigio RAL 9006

Sistema di fissaggio: a plafone o con adattatore per binario (non incluso)

Range of adjustable indoor projectors.

Light emission: direct

Optic: pure aluminium goffered and anodized

Wiring: CR (electromechanical high power factor) - CAE (with high frequency ballast)

Available colours:

- 01 white RAL 9016
- 05 gray RAL 9006

Fixing kit: surface mounting or track adapter (not included)

cod. **240** Taki



Articolo Code	Potenza Power (Watt)	Attacco Pin	Peso Weight
• 240/JM70/ *	1x70	Rx7s	3,5
• 240/JM150/ *	1x150	Rx7s	4,5

- * = tipo di cablaggio - wiring type (CR - CAE)
- = codice consegna (pag. 8) - delivery code (pag. 8)

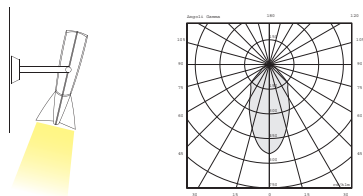
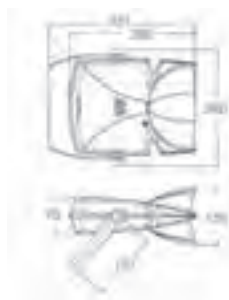

cod. **240** Taki G

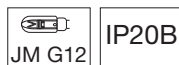

Articolo Code	Potenza Power (Watt)	Attacco Pin	Peso Weight
• 240/JM70G/ *	1x70	G12	3,5
• 240/JM150G/ *	1x150	G12	4,5

- * = tipo di cablaggio - wiring type (CR - CAE)
- = codice consegna (pag. 8) - delivery code (pag. 8)

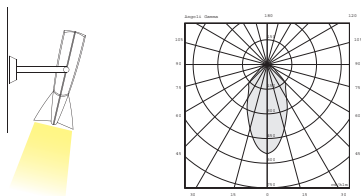
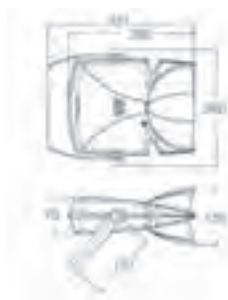

cod. **KT** accessori a richiesta

- • **KT21010** - basetta attacco a plafone assemblata - wall fixing bracket
- • **KT21011** - adattatore per binario assemblato - adapter for track assembly
- = codice consegna (pag. 8) - delivery code (pag. 8)

cod. **F** filtri - filter



Articolo Code	descrizione description
FBR	filtro pane - bread filter
FFH	filtro pesce - fish filter
FNT	filtro carne - meat filter
FVE	filtro verdura - vegetable filter
FFR	filtro frutta - fruit filter

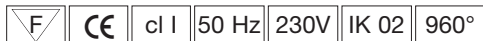

Serie di apparecchi regolabili per uso interno.

Range of adjustable indoor projectors.

Emissione: diretta

Light emission: direct

Cablaggi: CAE (alimentatore elettronico)

Wiring: CAE (high frequency ballast)

Colori disponibili:

01 bianco RAL 9016
05 grigio RAL 9006

Available colours:

01 white RAL 9016
05 gray RAL 9006

cod. **241** Taki Alo



IP20B

Articolo Code	Potenza Power (Watt)	Attacco Pin	Peso Weight
• 241/ *	1x50	Gx 5,3	0,75

* = tipo di cablaggio - wiring type (CAE)

• = codice consegna (pag. 8) - delivery code (pag. 8)

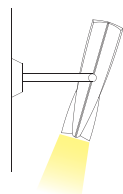

cod. **KT** accessori a richiesta

- **KT21010** - basetta attacco a plafone assemblata
- wall fixing bracket
- **KT21011** - adattatore per binario assemblato
- adapter for track assembly

• = codice consegna (pag. 8) - delivery code (pag. 8)



Serie di apparecchi regolabili per uso interno.

Riflettore: alluminio purissimo ossidato e brillantato anodicamente

Diffusore: cristallo di protezione temperato. A richiesta cristallo frontale con parziale assorbimento di raggi ultravioletti

Cablaggi: CR (cablato rifasato) - CAE (con alimentatore elettronico), portalampada in ceramica.

Piastra di cablaggio in acciaio zincato contenente tutti i componenti elettrici

Colori disponibili:

- ☐ 01 bianco RAL 9016
- 02 nero RAL 9005
- 05 grigio RAL 9006

Range of adjustable indoor projectors.

Reflector: oxidized, anode-process-polished, extra pure aluminium

Diffuser: shock-proof tempered protection glass. Front glass with partial UV rays filtering available on demand

Wiring: CR (high power factor) - CAE (with high frequency ballast).

Zinc-coated steel plate containing all the electric parts. Ceramic bulb socket

Available colours:

- ☐ 01 white RAL 9016
- 02 black RAL 9005
- 05 gray RAL 9006

cod. **KVGU** Vogue



Articolo Code	Potenza Power (Watt)	Attacco Pin	Peso Weight (Kg)
• KVGU70/JM70/ *	70	Rx7s	4,0
• KVGU150/JM150/ *	150	Rx7s-24	4,5

* = tipo di cablaggio - wiring type (CR - CAE)
 • = codice consegna (pag. 8) - delivery code (pag. 8)



cod. **KT** accessori a richiesta

- **KT21010** - basetta attacco a plafone assemblata - wall fixing bracket
- **KT21011** - adattatore per binario assemblato - adapter for track assembly

• = codice consegna (pag. 8) - delivery code (pag. 8)



Riflettore: alluminio purissimo ossidato e brillantato anodicamente

Reflector: oxidized, anode-process-polished, extra pure aluminium

Diffusore: cristallo di protezione temperato

Diffuser: shock-proof tempered protection glass

Cablaggi: scatola di cablaggio in nylon F.V. completa di snodo per l'orientamento del faretto. Portalampada in ceramica. Morsetto in nylon F.V.

Wiring: fibreglass reinforced nylon wiring box, complete with joint for spotlight adjustment. Ceramic bulb socket. Fibreglass reinforced nylon clamp

Colori disponibili:

- ☐ 01 bianco RAL 9016
- 02 nero RAL 9005

Available colours:

- ☐ 01 white RAL 9016
- 02 black RAL 9005

A richiesta: squadretta di fissaggio in acciaio

On request: steel fixing square

cod. **KJOT** Jota



Articolo Code	Potenza Power (Watt)	Attacco Pin	Peso Weight (Kg)
• KJOT300/B	300	R7s	1,0
• KJOT300/V	300	R7s	1,0
• KJOT300/T	300	R7s	1,0

B = basetta in nylon - nylon fixing base
V = staffa in acciaio - steel fixing square
T = tiges fissa - fixed hanger (500 mm - ø 20 mm)

• = codice consegna (pag. 8) - delivery code (pag. 8)

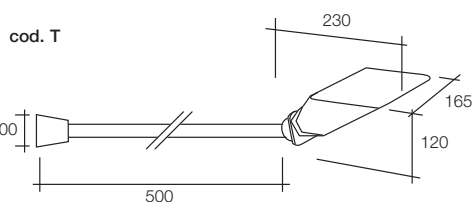
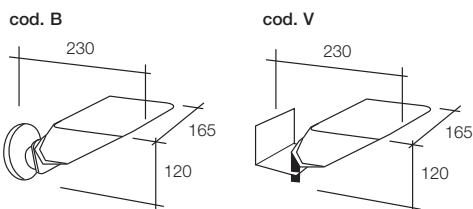

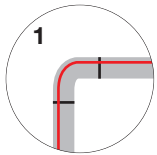
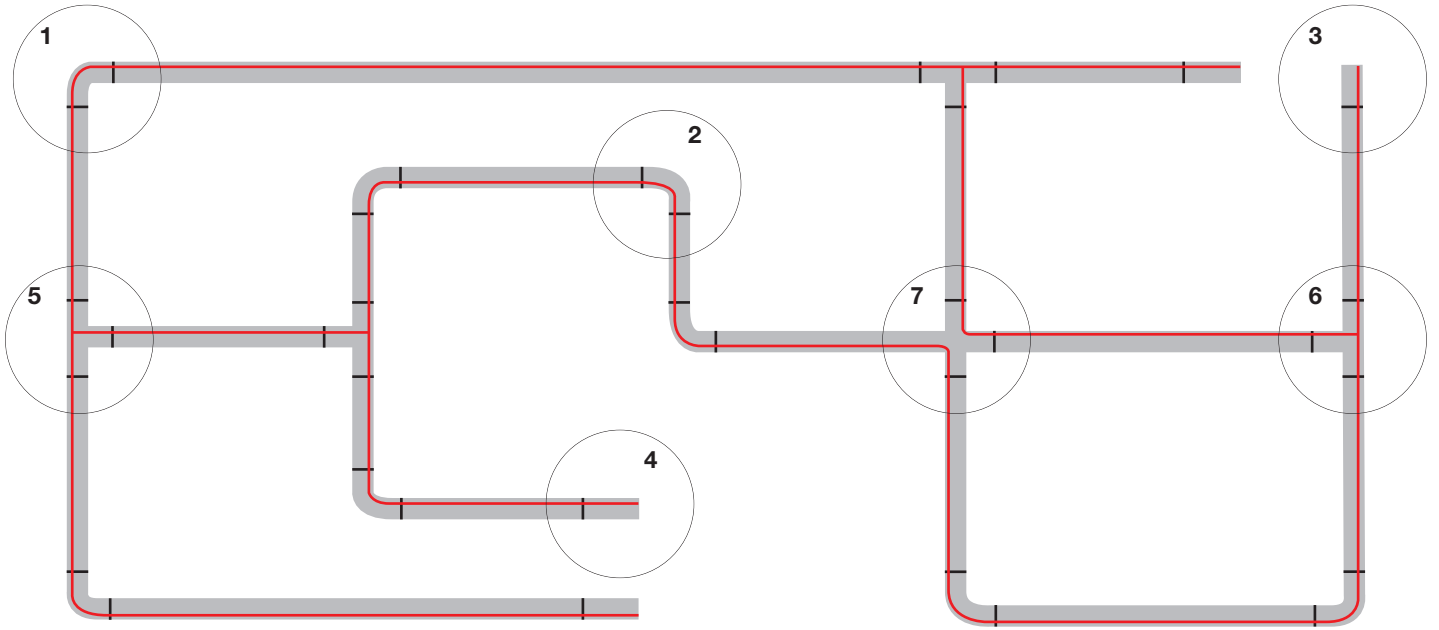

1
Giunto L esterno
Outside L joint

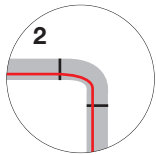

2
Giunto L interno
Inside L joint

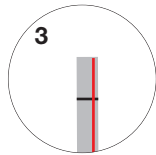

3
Alimentazione destra
Right live-end

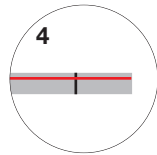

4
Alimentazione sinistra
Left live-end

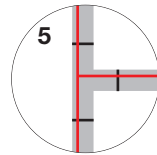

5
Giunto T destro
Right T joint

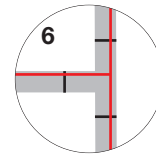

6
Giunto T sinistro
Left T joint

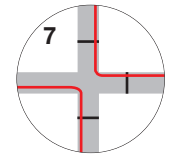

7
Giunto a X
X joint

Posizionamento dell'alimentazione dei conduttori di terra - Position of the supply of earth conductors

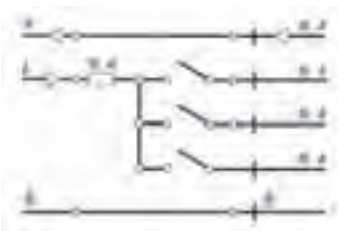

Schema elettrico monofase a tensione di rete 230/250V
One-phase electric diagram for mains voltage 230/250V

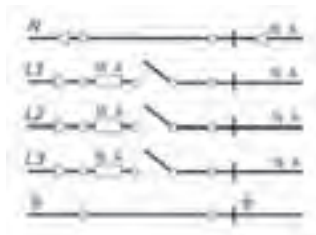

Schema elettrico trifase a tensione di rete 230/400V
Three-phase electric diagram for mains voltage 230/400V

Portata/peso - Capacity/weight

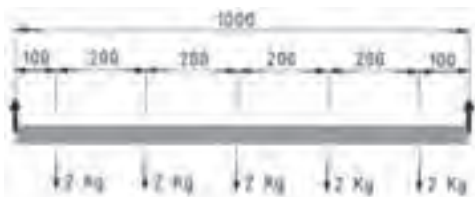

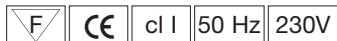

Realizzato in profilo di alluminio a sezione quadrata, BINARIO si presenta con una linea semplice ma tecnica.

Manufactured in square profile extruded aluminium, BINARIO thus presenting a simple but highly technical range.

Dispone anche di una serie di accessori che consentono combinazioni e percorsi differenti.

The track allows various accessories which achieve a variety of lighting solutions.

Colori disponibili:

- ☐ **01** bianco RAL 9016
- ☐ **05** grigio RAL 9006

Available colours:

- ☐ **01** white RAL 9016
- ☐ **05** gray RAL 9006

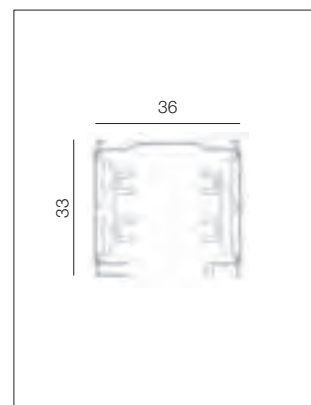

cod. **7511** Binario



Articolo Code	lunghezza length (mm)
7511/10	1000
7511/20	2000
7511/30	3000

Accessori



cod. **7653-10**
Alimentazione centrale e giunto lineare

Central connector and straight joint

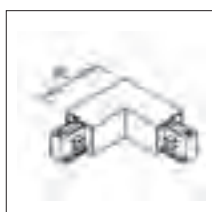

cod. **7655-10**
Giunto L interno

Inside L joint



cod. **7655-11**
Giunto L esterno

Outside L joint

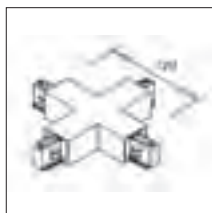

cod. **7656-10**
Giunto T destro

Right T joint



cod. **7656-11**
Giunto T sinistro

Left T joint

cod. **7657-10**
Giunto X

X joint



cod. **7658-10**
Giunto flessibile

Flexible joint

cod. **7604-10**
giunto lineare con contatti

Electrical straight joint

cod. **7654-10**
giuntoi lineare senza contatti

Mechanical joint

Accessori



cod. **7659-00**
Chiusura

Dead end



cod. **7624-00**
Copertura binario mm 1000

Track cover mm 1000



cod. **7607-00**
Kit attacco soffitto

Ceiling kit



cod. **7606-00**
Sospensione kit cavo acciaio mm 2000 (L. 60 mm)

Suspension kit with steel wire mm 2000 (L. 60 mm)

cod. **7606-05**
L. = 120 mm

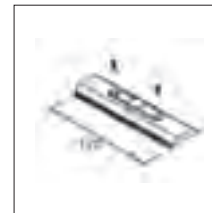

cod. **7606-04**
Piatina L. 120 mm

Plate L. 120 mm



cod. **7601-11**
Adattatore c/trasf. elettr. 50W con jack femmina

Adapter with transformer 50W with female jack

Accessori



cod. **7601-00**
Adattatore meccanico/elettrico 6A - carico meccanico 5 Kg

Mechanical/electrical adapter 6A - mechanical load 5 Kg



cod. **7625-00**
Adattatore meccanico

Mechanical/electrical adapter



cod. **7652-10**
Alimentazione destra

Right live-end

cod. **7652-10**
Alimentazione sinistra

Left live-end