



15



Registered Design



codice lampada

Apparecchio con diffusore microprismato con cablaggio elettronico a doppia accensione 50%/100%

4577 4x55 W TC-L

Apparecchio con diffusore microprismato con cablaggio elettronico dimmerabile DALI e regolazione luminosa manuale

4578 4x55 W TC-L

Apparecchio con diffusore microprismato con cablaggio elettronico dimmerabile DALI e sensore di presenza e di lux

4579 4x55 W TC-L

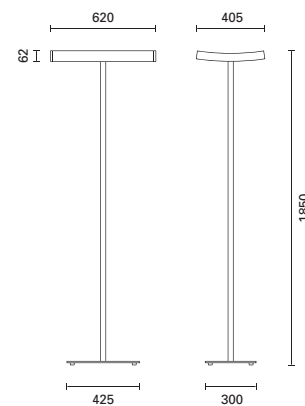
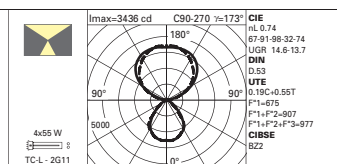

Apparecchio con riflettore microforato $L \leq 1000 \text{ cd/m}^2$ $\alpha \geq 65^\circ$, cablaggio elettronico a doppia accensione 50%/100%

4574 4x55W TC-L

Apparecchio con riflettore microforato $L \leq 1000 \text{ cd/m}^2$ $\alpha \geq 65^\circ$, cablaggio elettronico dimmerabile DALI e regolazione luminosa manuale

4575 4x55W TC-L

Apparecchio con riflettore microforato $L \leq 1000 \text{ cd/m}^2$ $\alpha \geq 65^\circ$, cablaggio elettronico dimmerabile DALI e sensore di presenza e di lux

4576 4x55W TC-L

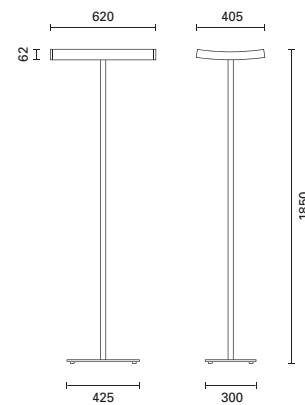
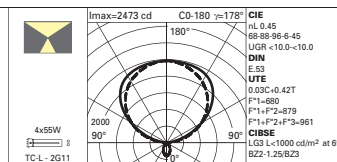

schermi



codice

Schermi superiori di protezione

9142

per 4574-4575-4577-4578

Disponibile nel colore 24



15



Registered Design



codice lampada

Cestello sospensione piccolo a 4 vani completo di trasformatori elettronici **3051** 4x50 W 12 V QR CBC 51



Completo di cavi di sospensione in acciaio e cavo di alimentazione L=2000 mm

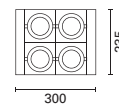
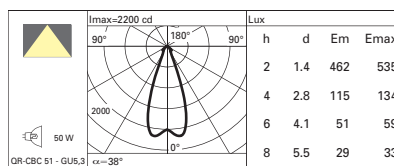
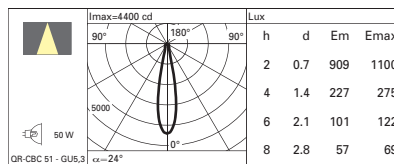
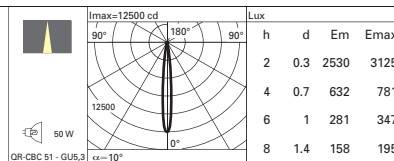

Cestello sospensione grande a 4 vani completo di trasformatori elettronici **3052** 4x100 W 12 V QR 111



Completo di cavi di sospensione in acciaio e cavo di alimentazione L=2000 mm

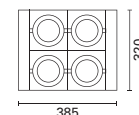
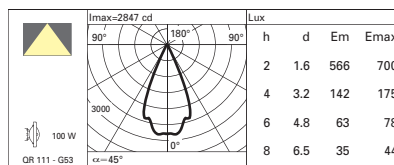
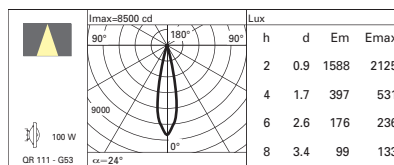
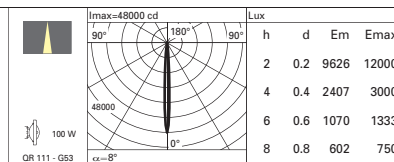

accessori



codice

Rifratore per distribuzione ellittica del flusso luminoso

8766 per 3051
8771 per 3052

Disponibile nel colore 24

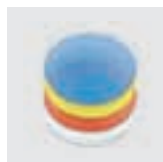
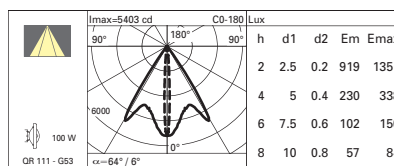
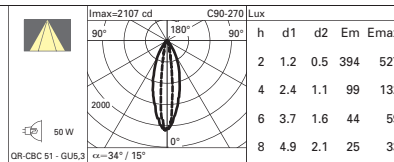

Filtri colorati
8753 per 3051
8754 per 3052

Disponibile nel colore 05-06-09-65



Frangiluce
8775 per 3051

Disponibile nel colore 04

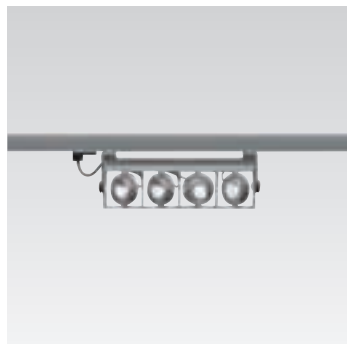
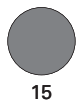

codice lampada

Cestello spot piccolo per binario a 4 vani completo di trasformatori elettronici
2729 4x50 W 12 V QR CBC 51

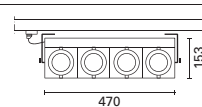
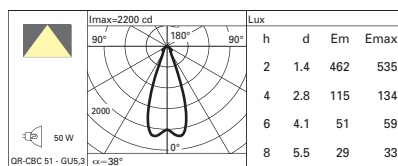
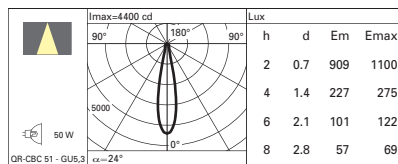
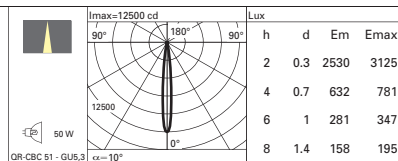

Cestello spot grande per binario a 4 vani completo di trasformatori elettronici
2730 4x100 W 12 V QR 111

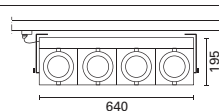
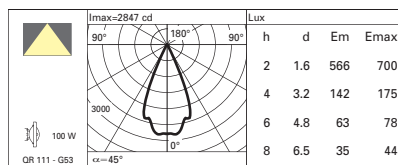
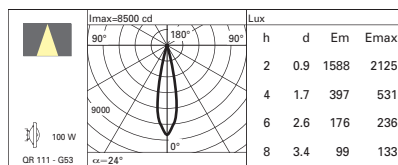
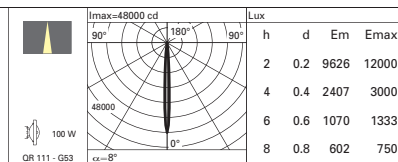

accessori

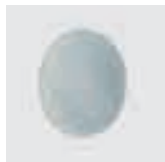

codice

Rifrattore per distribuzione ellittica del flusso luminoso

8766
per 2729
8771
per 2730

Disponibile nel colore 24

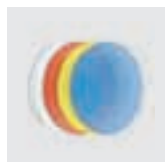
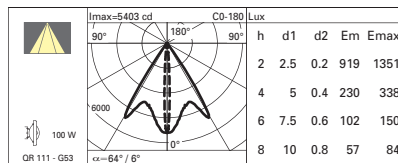
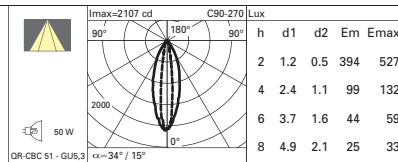

Filtri colorati
8753
per 2729
8754
per 2730

Disponibile nel colore 05-06-09-65

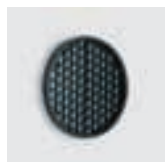

Frangiluce
8775
per 2729

Disponibile nel colore 04



15



Registered Design



codice lampada

Cestello applique piccolo a 4 vani completo di trasformatori elettronici
5181 4x50 W 12 V QR CBC 51



Completo di una tige di ancoraggio orientabile

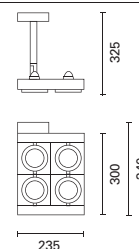
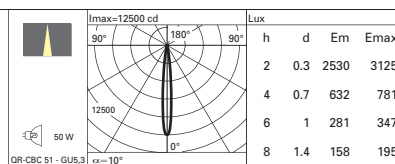

Cestello applique piccolo a 4 vani completo di trasformatori elettronici
5179 4x50 W 12 V QR CBC 51



Completo di una tige di ancoraggio orientabile

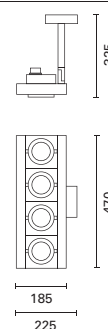
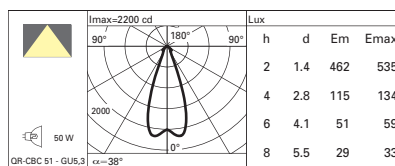

accessori



codice

Rifrattore per distribuzione ellittica del flusso luminoso
8766

Disponibile nel colore 24

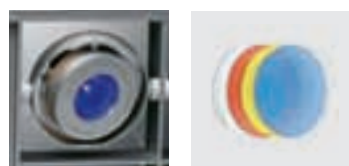
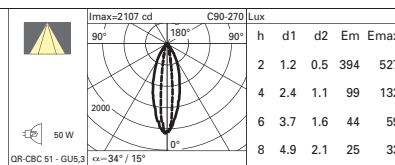

Filtri colorati
8753

Disponibile nel colore 05-06-09-65



Frangiluce
8775

Disponibile nel colore 04



15



Registered Design



codice lampada

Cestello applique grande a 4 vani
completo di trasformatori elettronici
5182 4x100 W 12 V QR 111



Completo di una tige di ancoraggio
orientabile

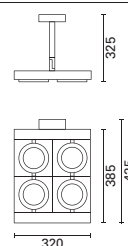
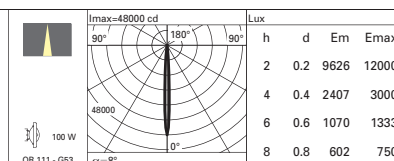

Cestello applique grande a 4 vani
completo di trasformatori elettronici
5180 4x100 W 12 V QR 111



Completo di due tiges di ancoraggio
orientabili

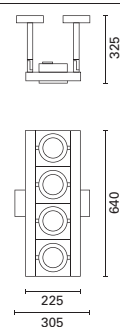
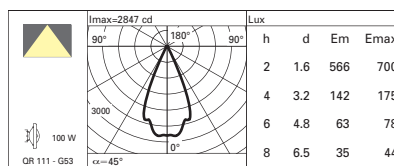

accessori



codice

Rifratore per distribuzione ellittica
del flusso luminoso
8771

Disponibile nel colore 24

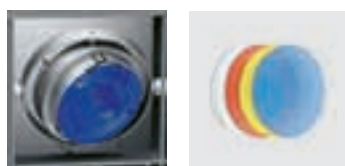
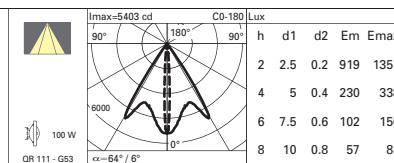

Filtri colorati
8754

Disponibile nel colore 05-06-09-65



15



Registered Design



codice lampada

Cestello piccolo a 6 vani completo di trasformatori h=2800 mm
4566 6x50 W 12 V QR CBC 51
 Cestello piccolo a 6 vani completo di trasformatori h=4500 mm
4567 6x50 W 12 V QR CBC 51

IP20

Predisposto per l'accensione separata di 3 gruppi di lampade alogene e dotato di cavo L= 2500 mm con spina

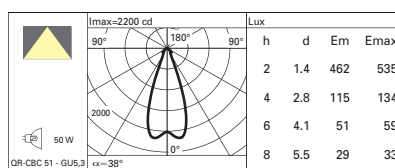
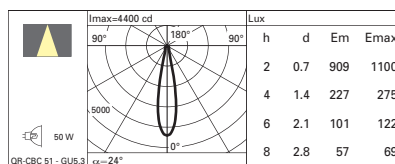
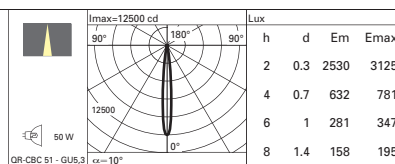

accessori



codice

Rifrattore per distribuzione ellittica del flusso luminoso
8766

Disponibile nel colore 24

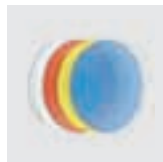
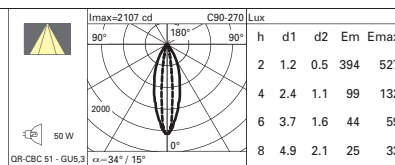

Filtri colorati
8753

Disponibile nel colore 05-06-09-65

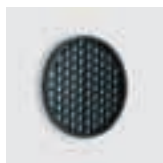

Frangiluce
8775

Disponibile nel colore 04



15



Registered Design

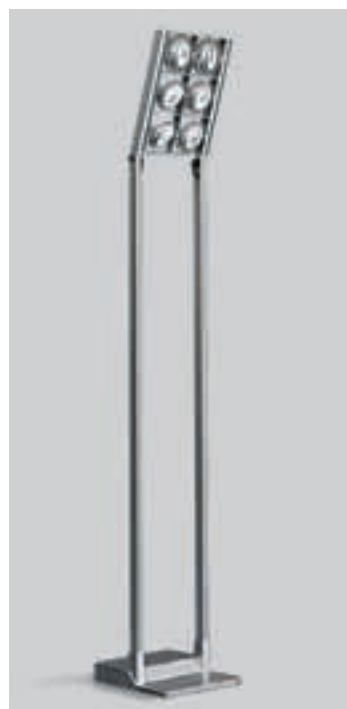

codice lampada

Cestello grande a 6 vani completo di trasformatori h=2800 mm
4568 6x100 W 12 V QR 111
 Cestello grande a 6 vani completo di trasformatori h=4500 mm
4569 6x100 W 12 V QR 111

IP20

Predisposto per l'accensione separata di 3 gruppi di lampade alogene e dotato di cavo L=2500 mm con spina

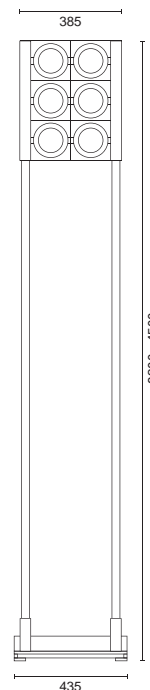
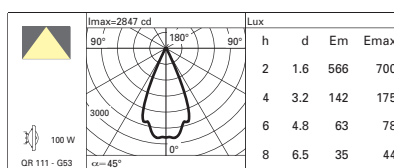
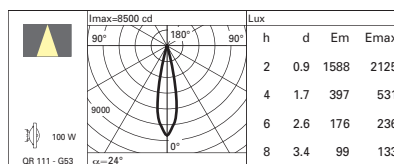
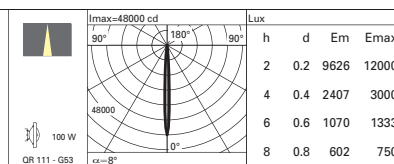

accessori

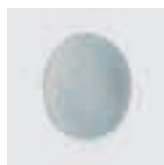

codice

Rifrattore per distribuzione ellittica del flusso luminoso
8771

Disponibile nel colore 24

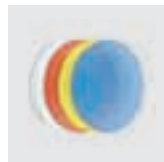
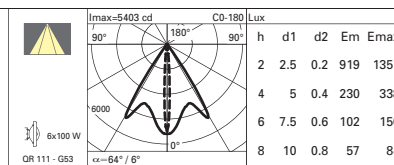

Filtri colorati
8754

Disponibile nel colore 05-06-09-65



10



codice lampada

Lampada da tavolo orientabile
a LED monocromatico

4059 6x1 W cool white

 IP20

Kg. 2,55

